

Médiathèque à la Madeleine





Rue Gambetta

Ecole
Edmond Rostand

Rue du Président
Georges Pompidou



CENTRAL

Directional signs (blurred)

Bus stop shelter (blurred text)

White car, dark car, white car, person in high-visibility vest



CENTRE EDOUARD DESCAZES

POLICE
MUNICIPALE

ACCES
ACCESIBILITE



Centraal Spoor

Centraal Spoor











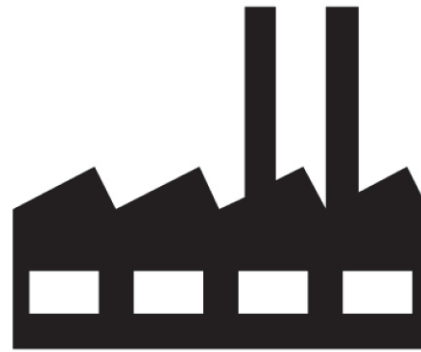



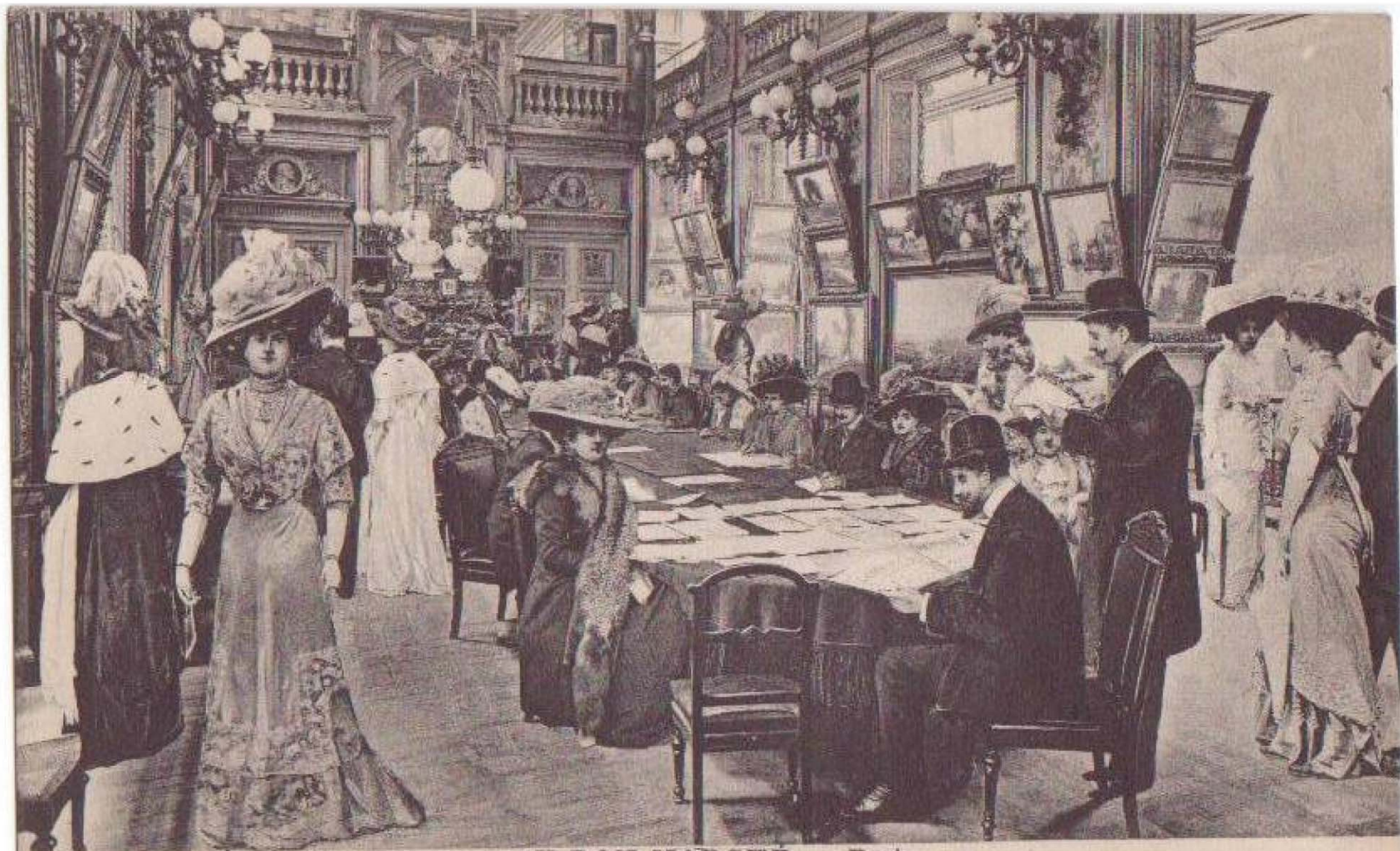

AU BON MARCHE. — Paris

Salon de Lecture et Exposition Permanente de Peinture et Sculpture. — ND Phot.

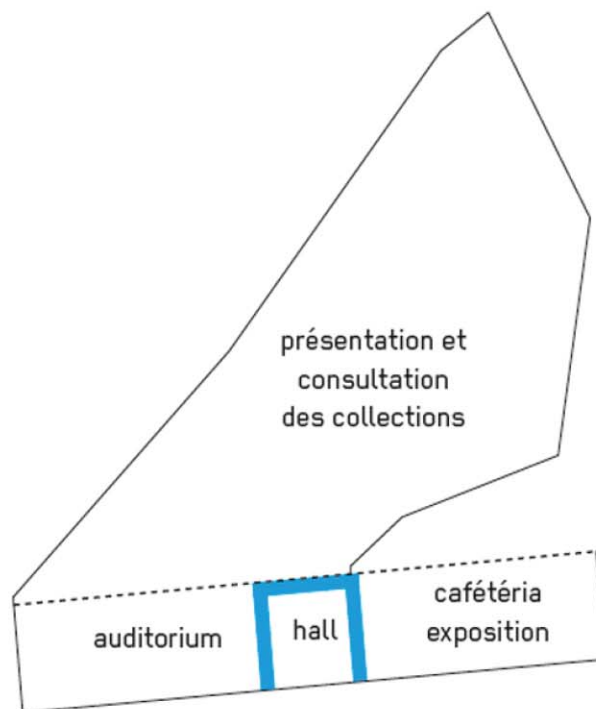
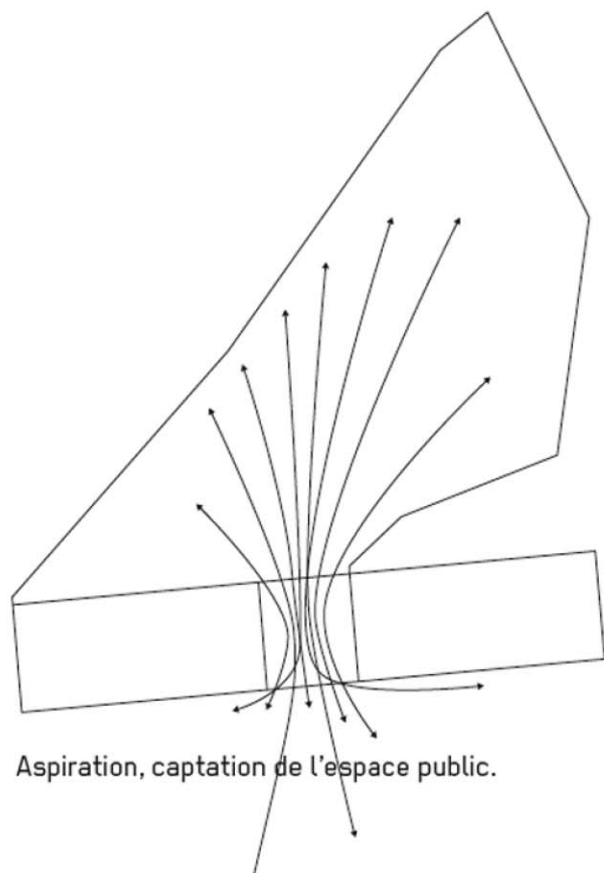

Gestion des accès en fonction des usages.

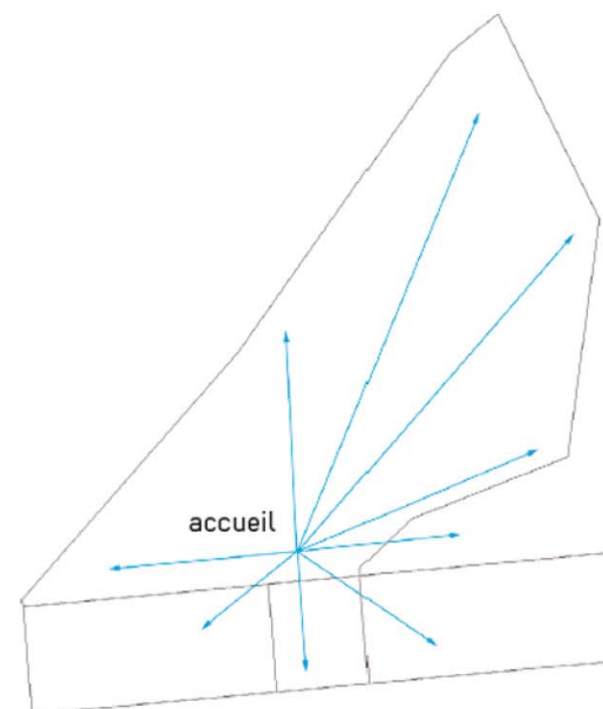

Vues panoramiques depuis l'accueil.

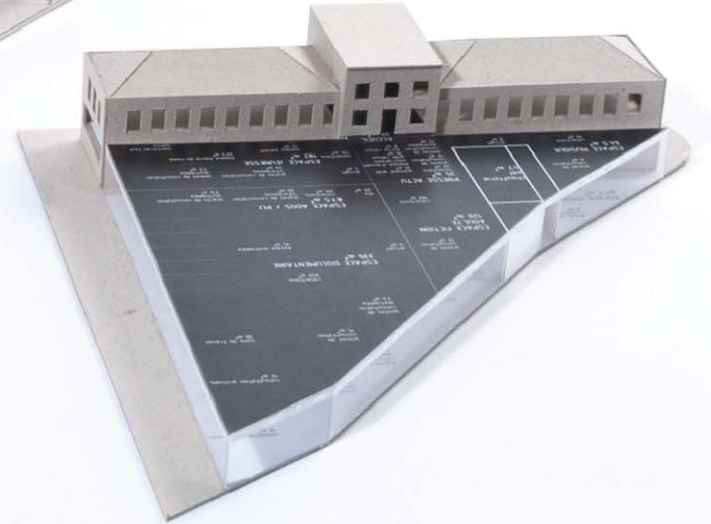
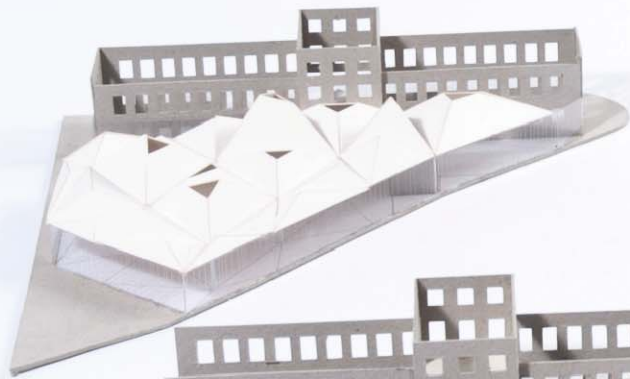



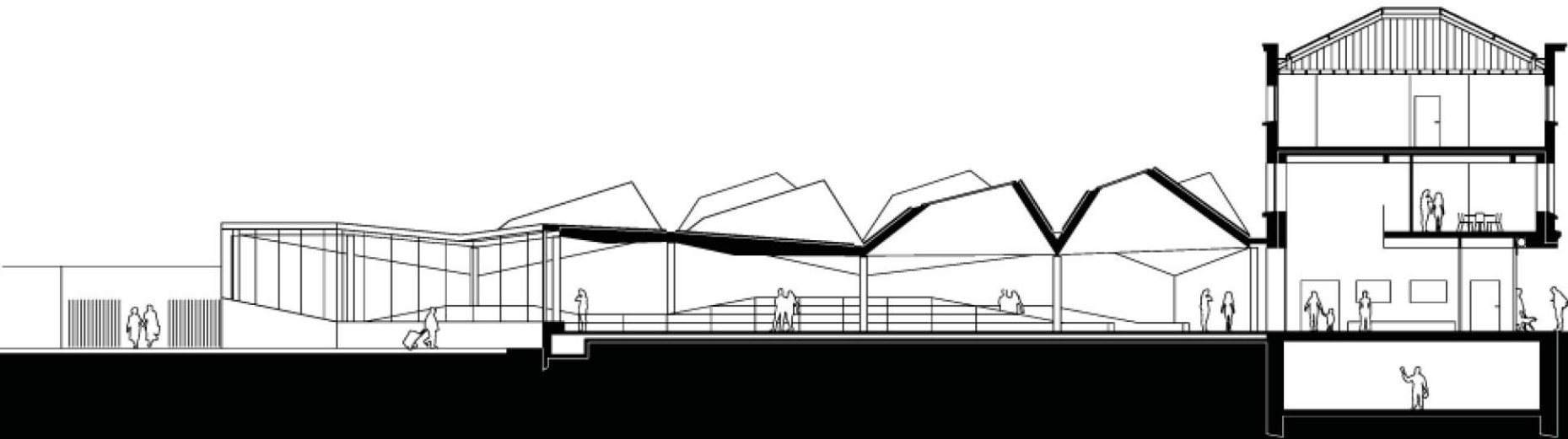

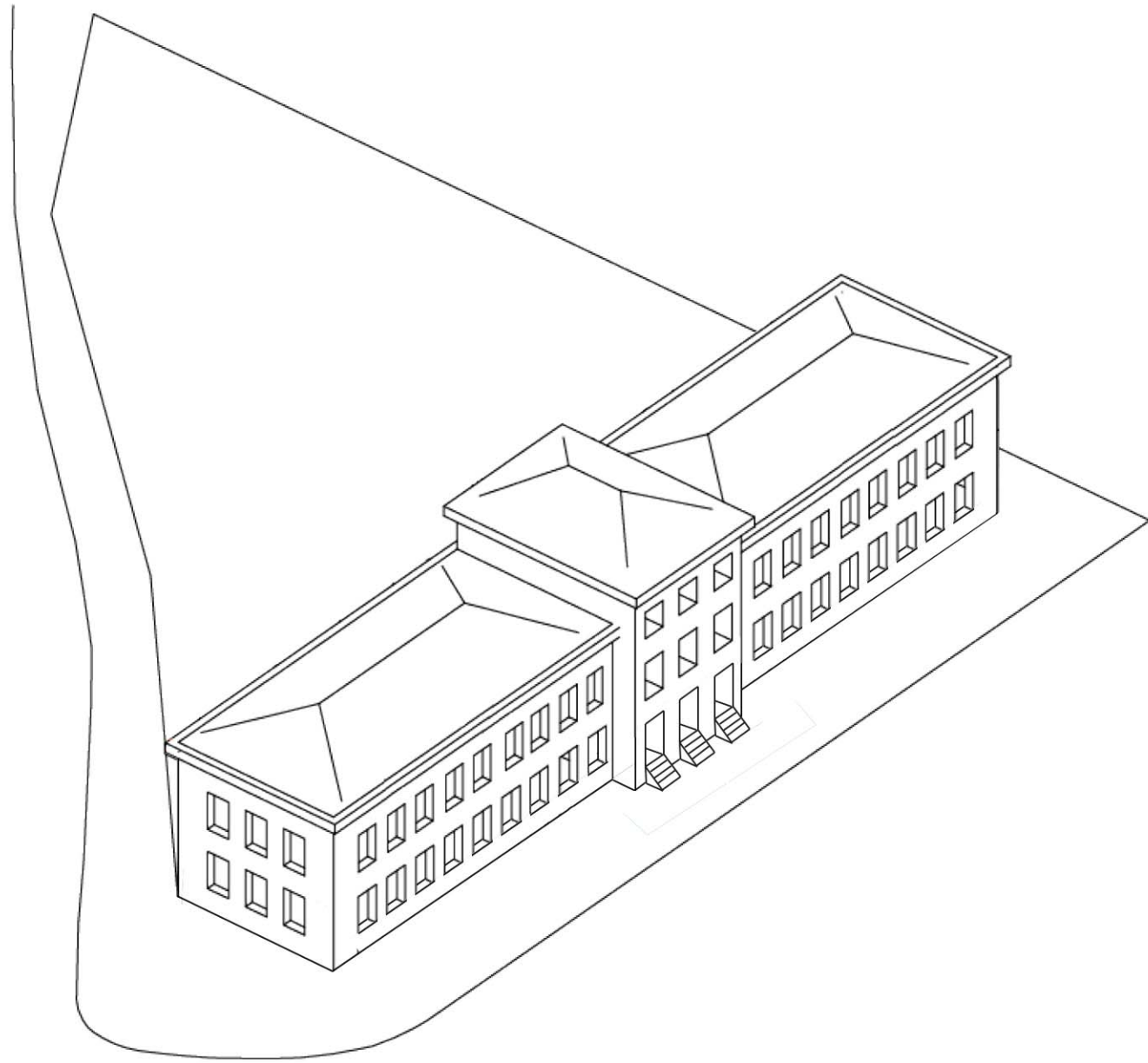

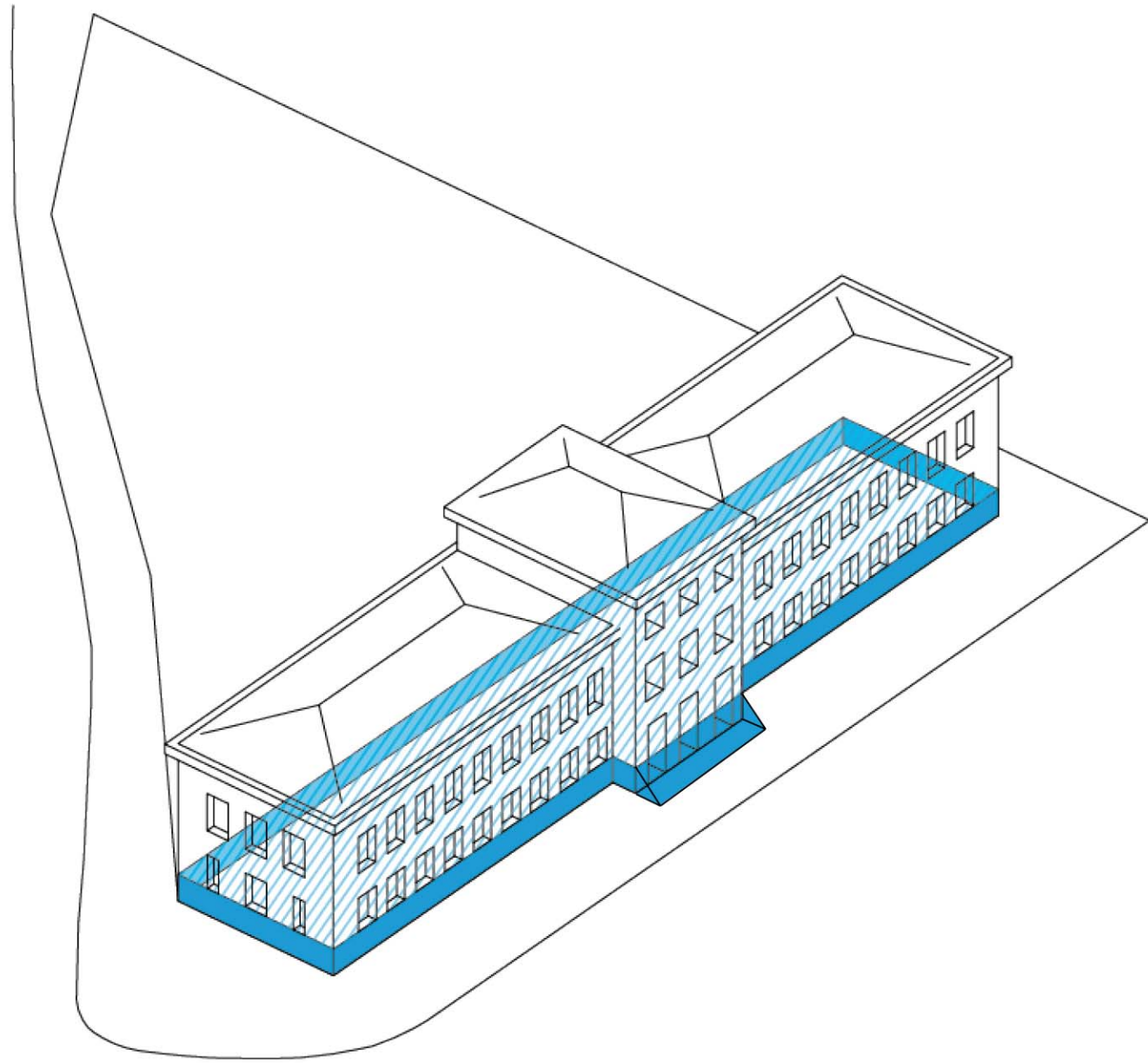

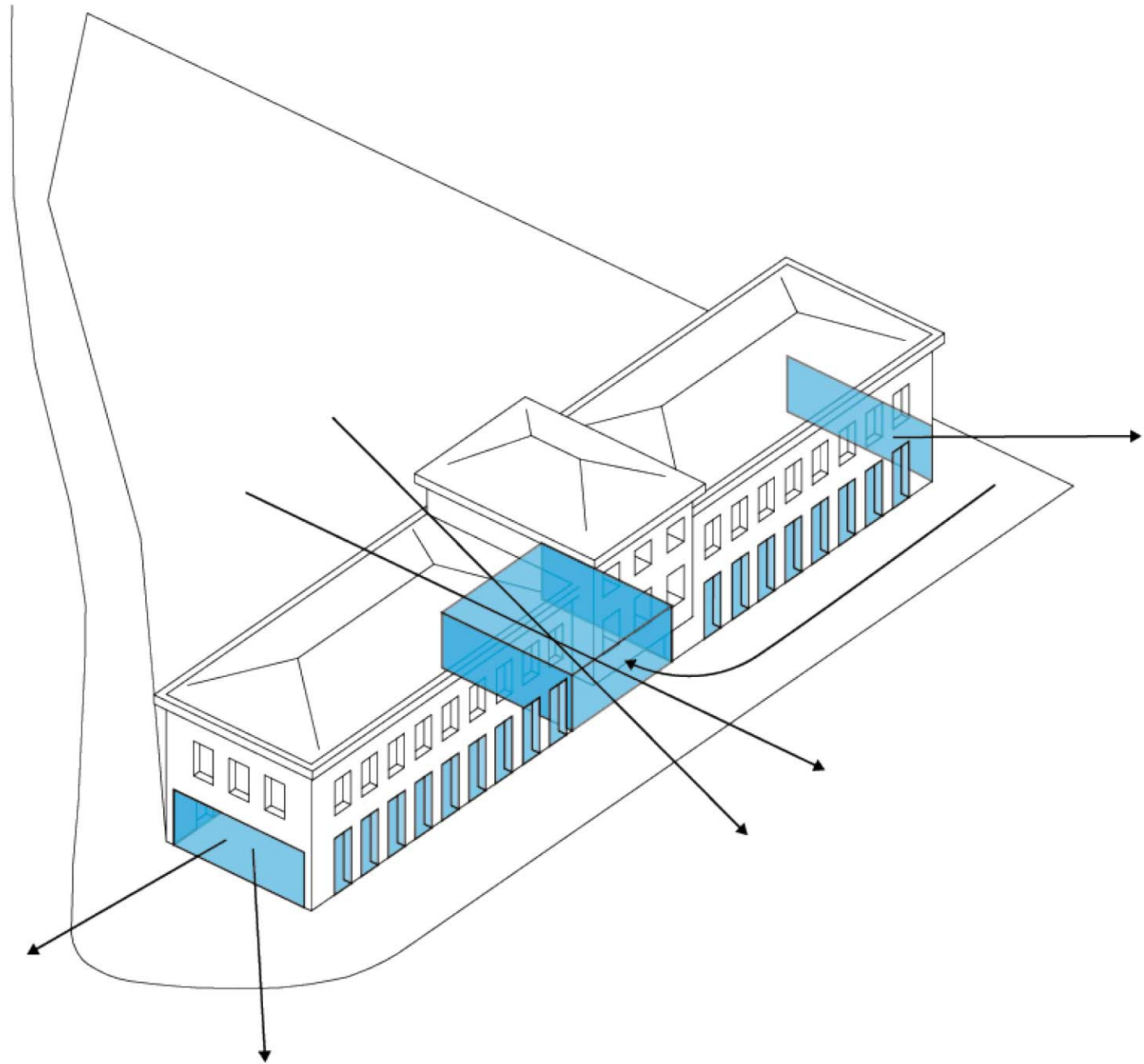

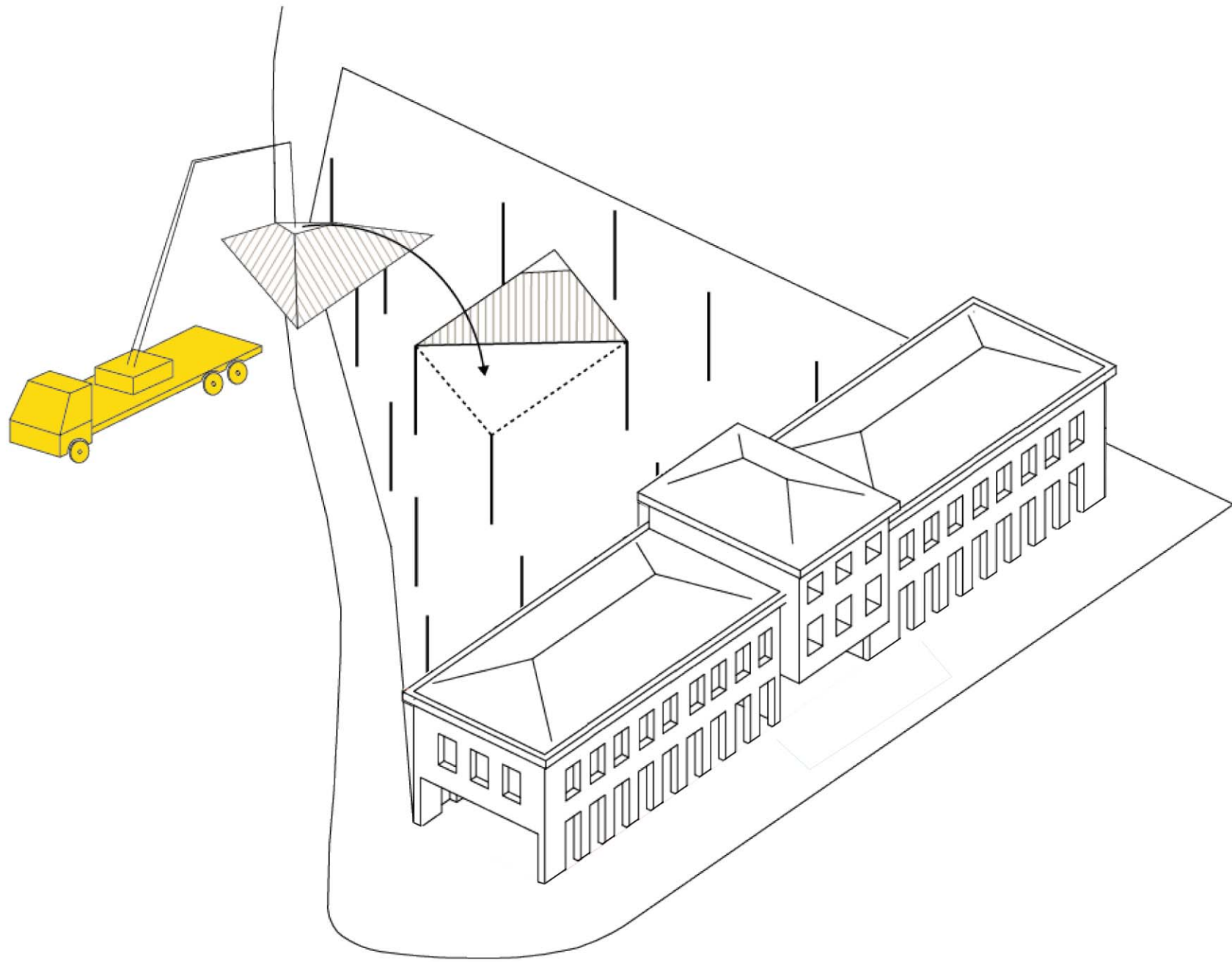

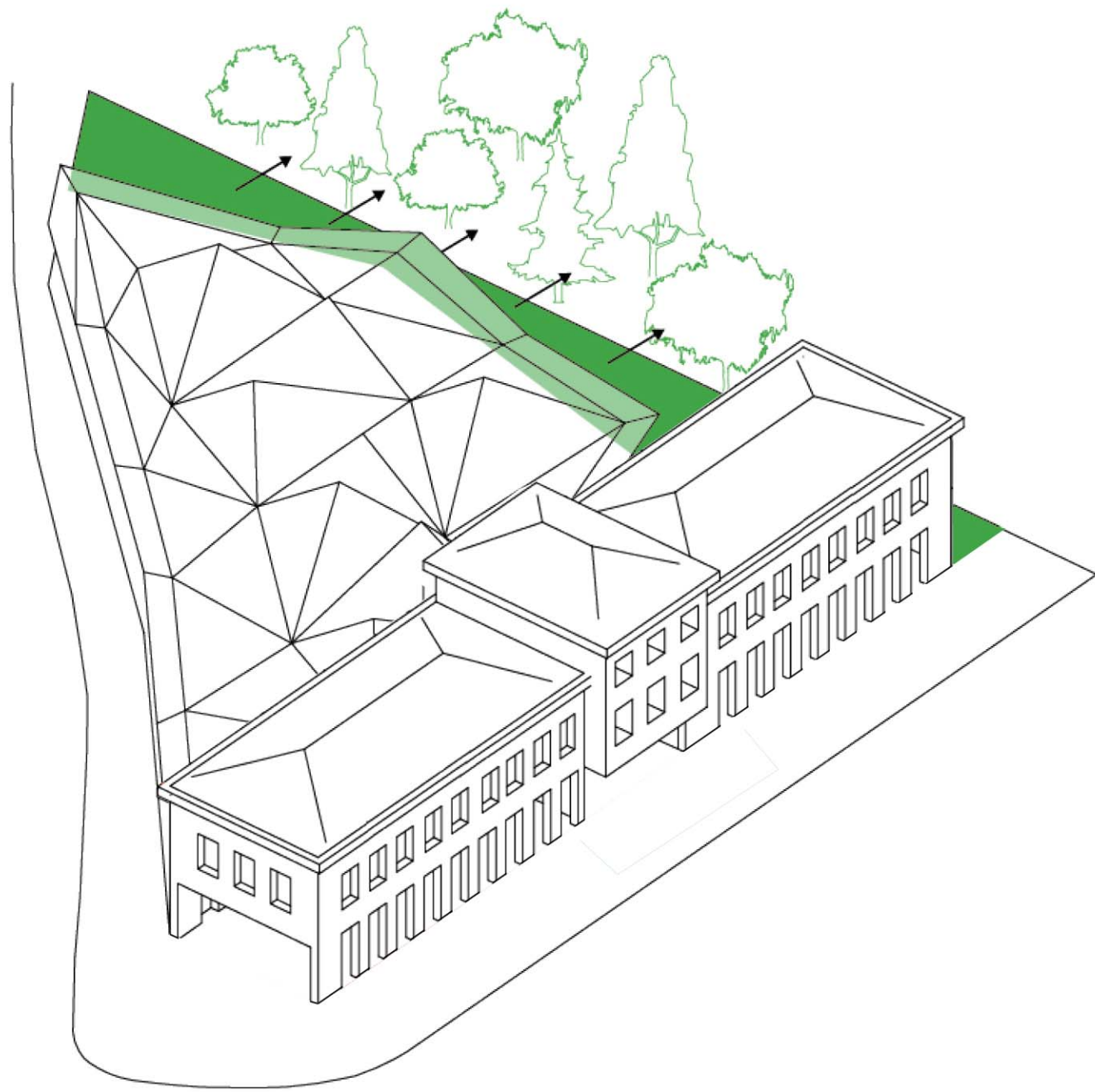

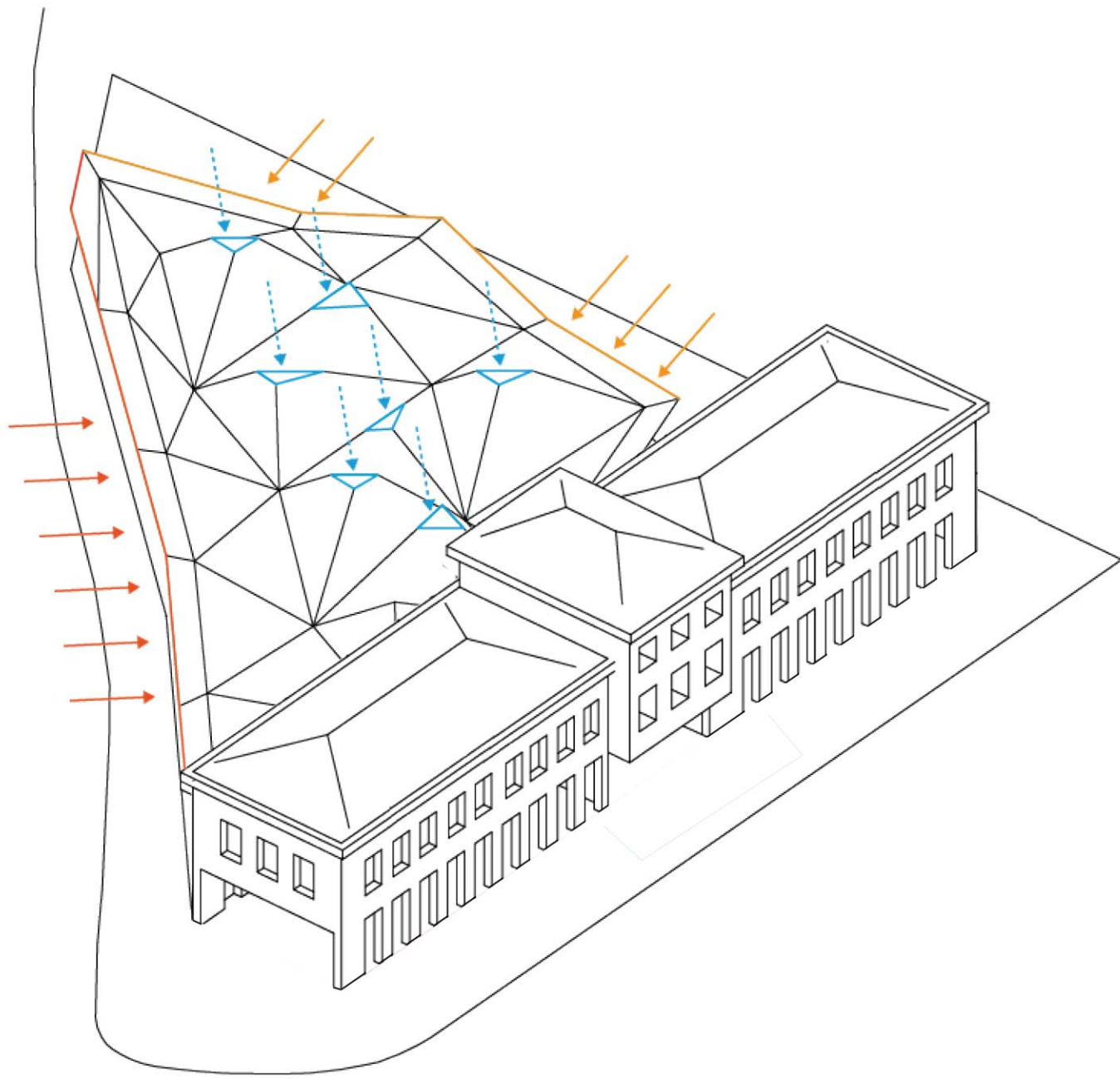

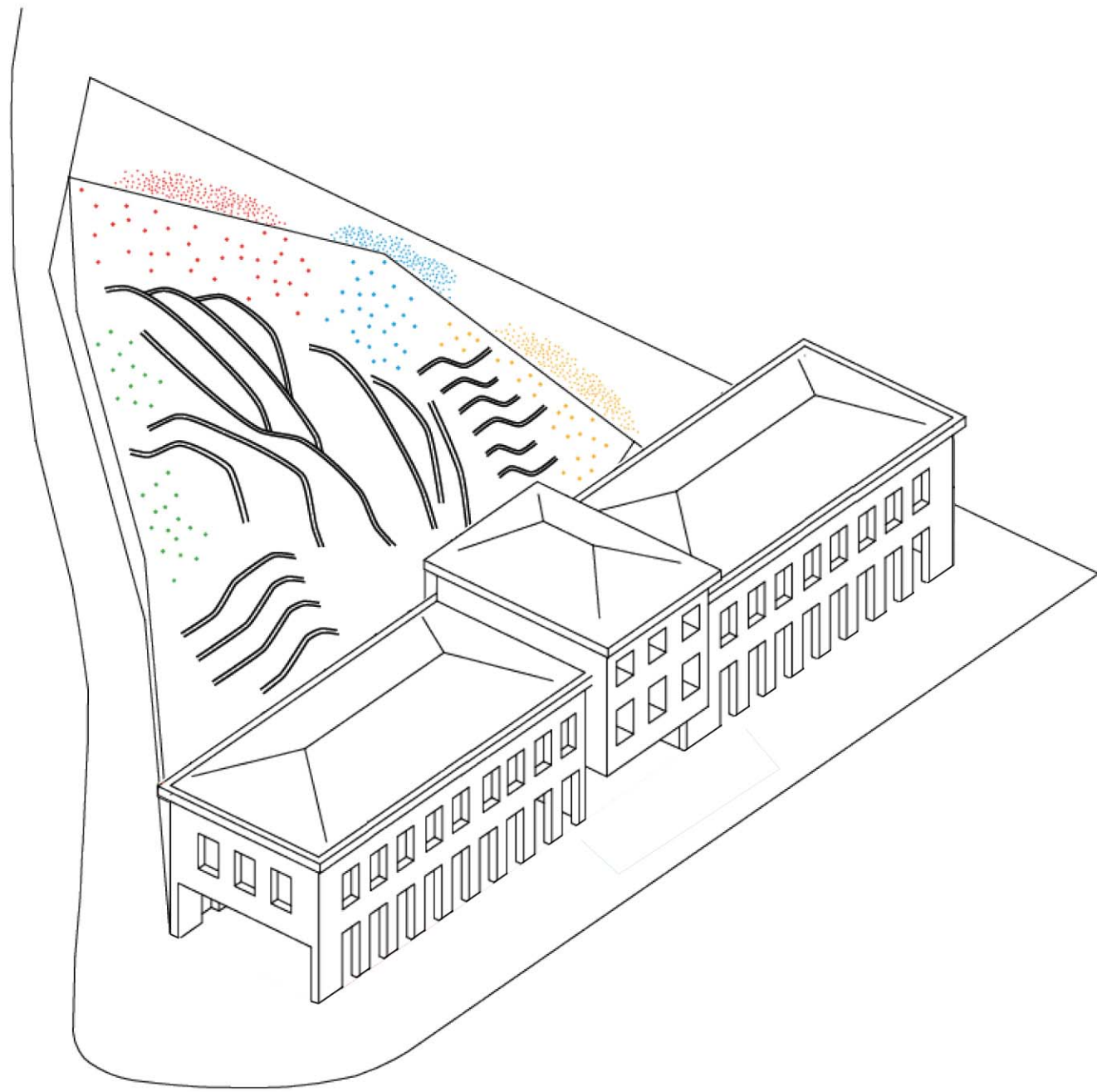

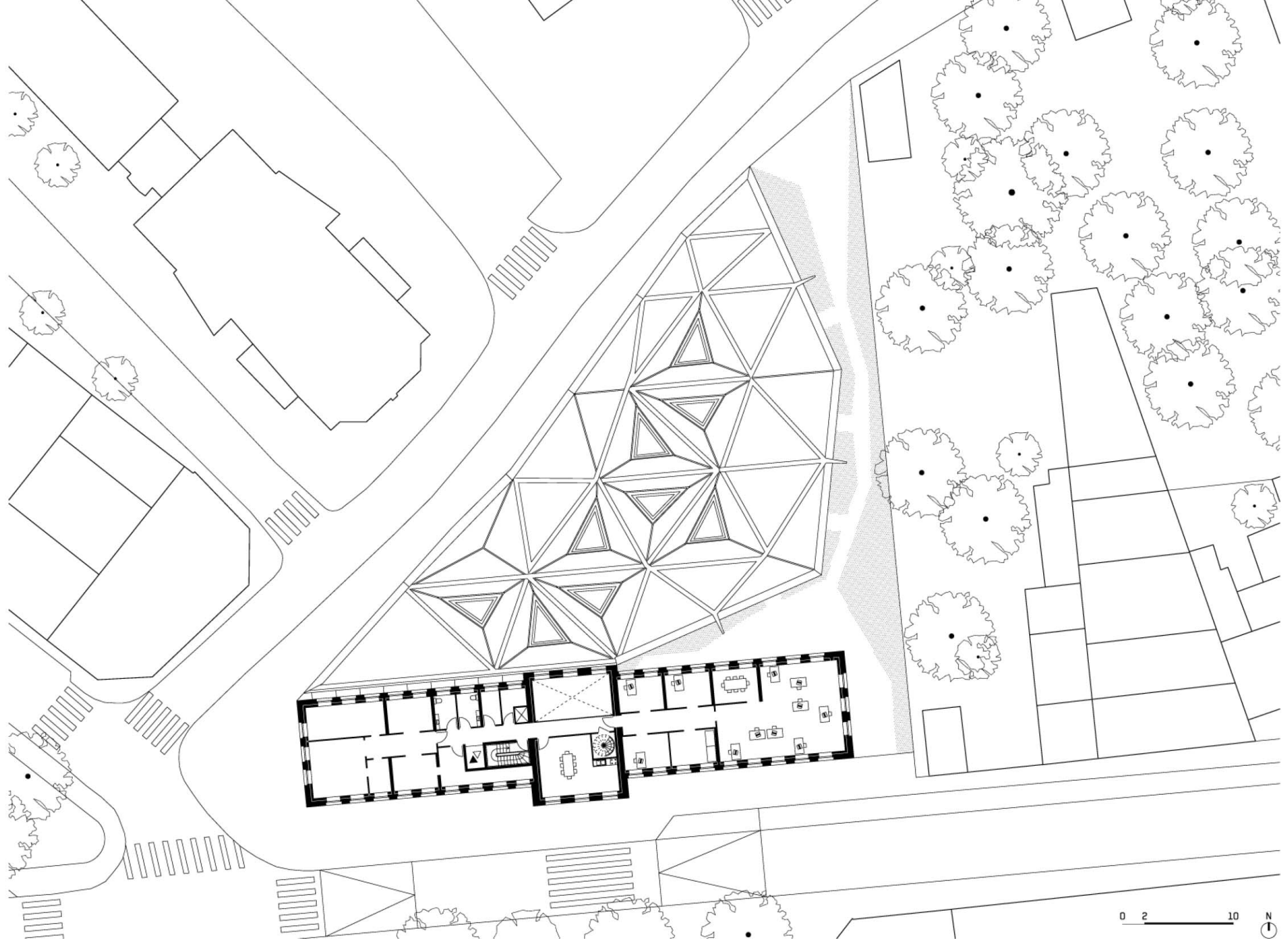

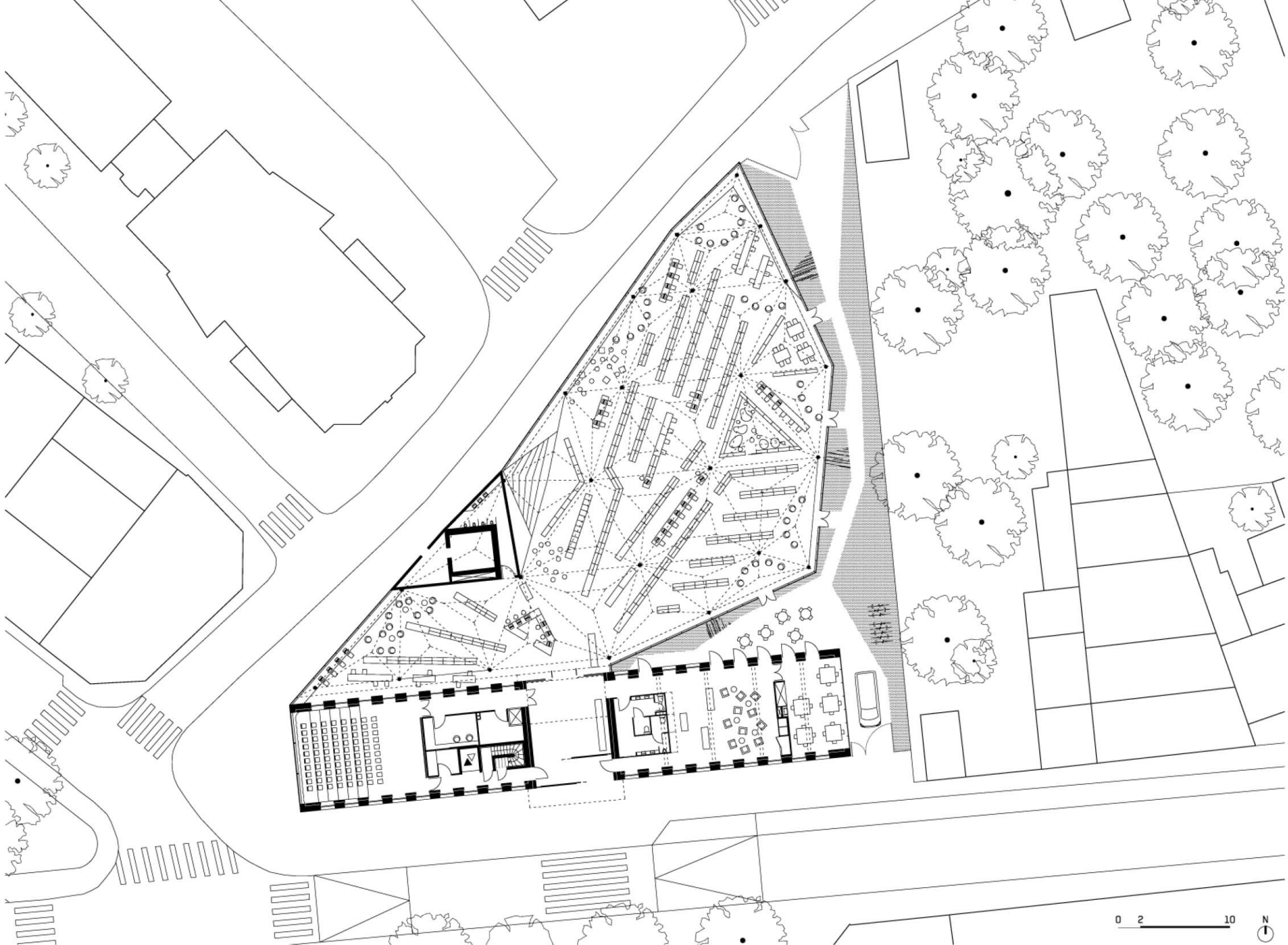

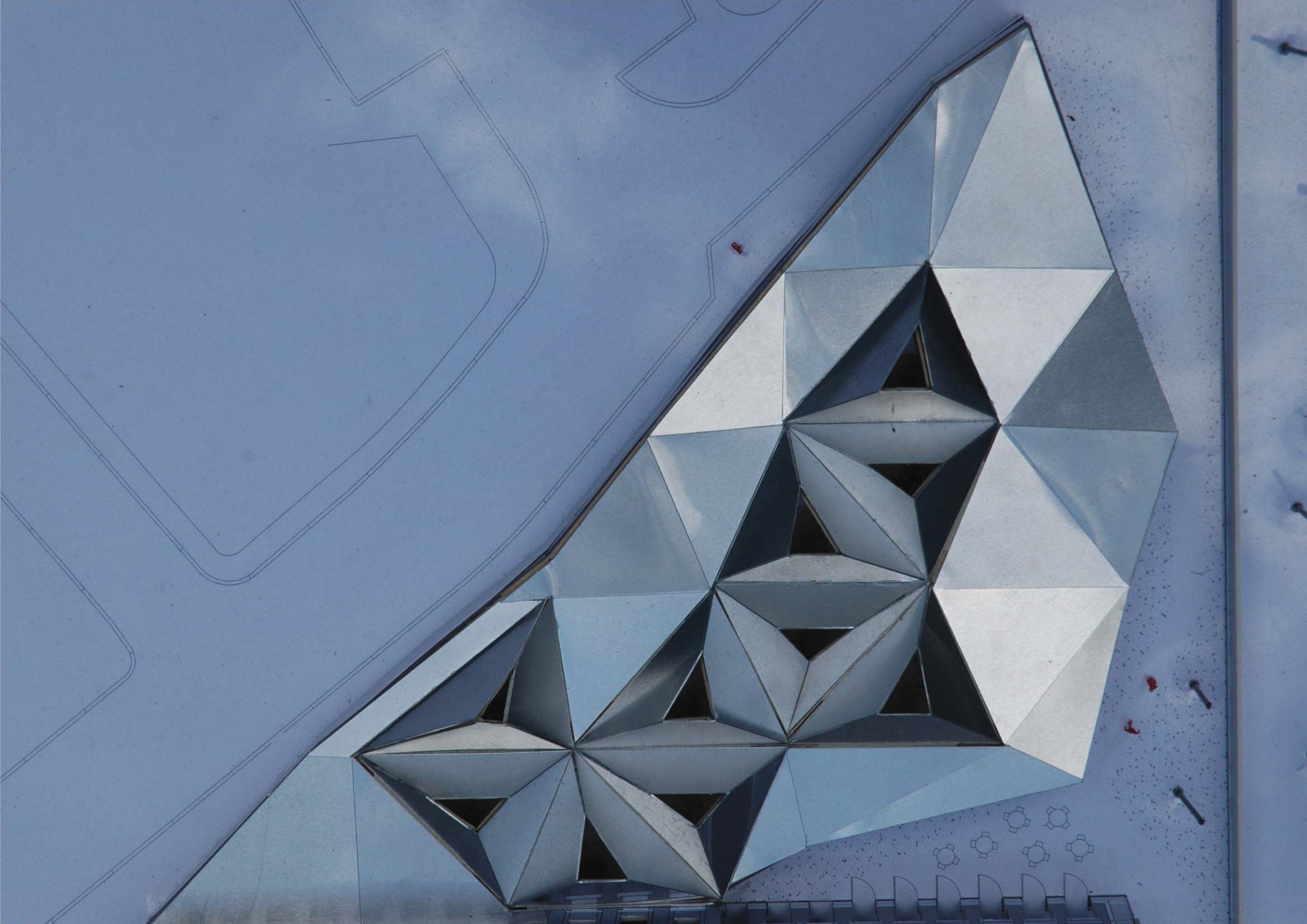

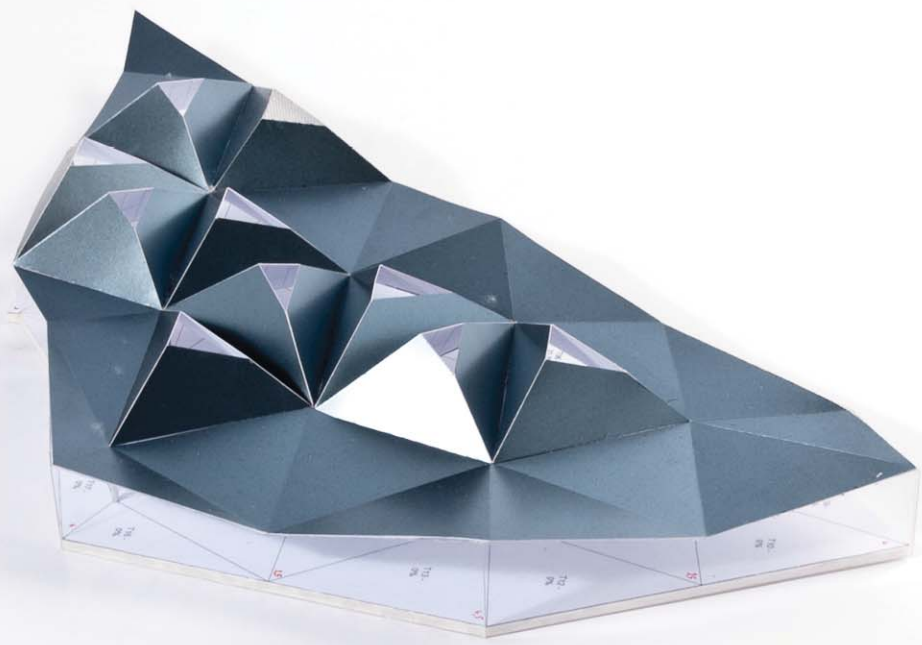



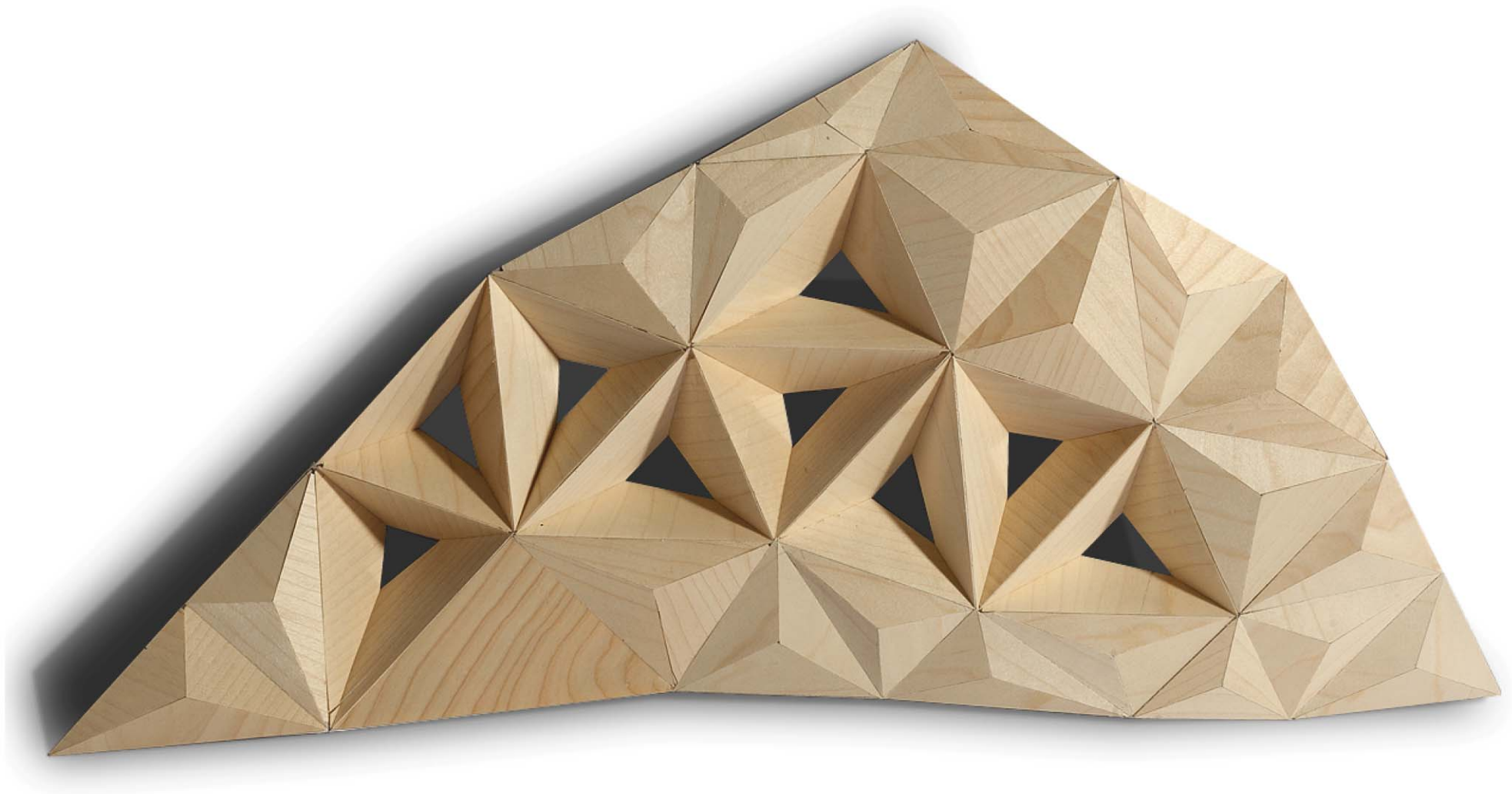

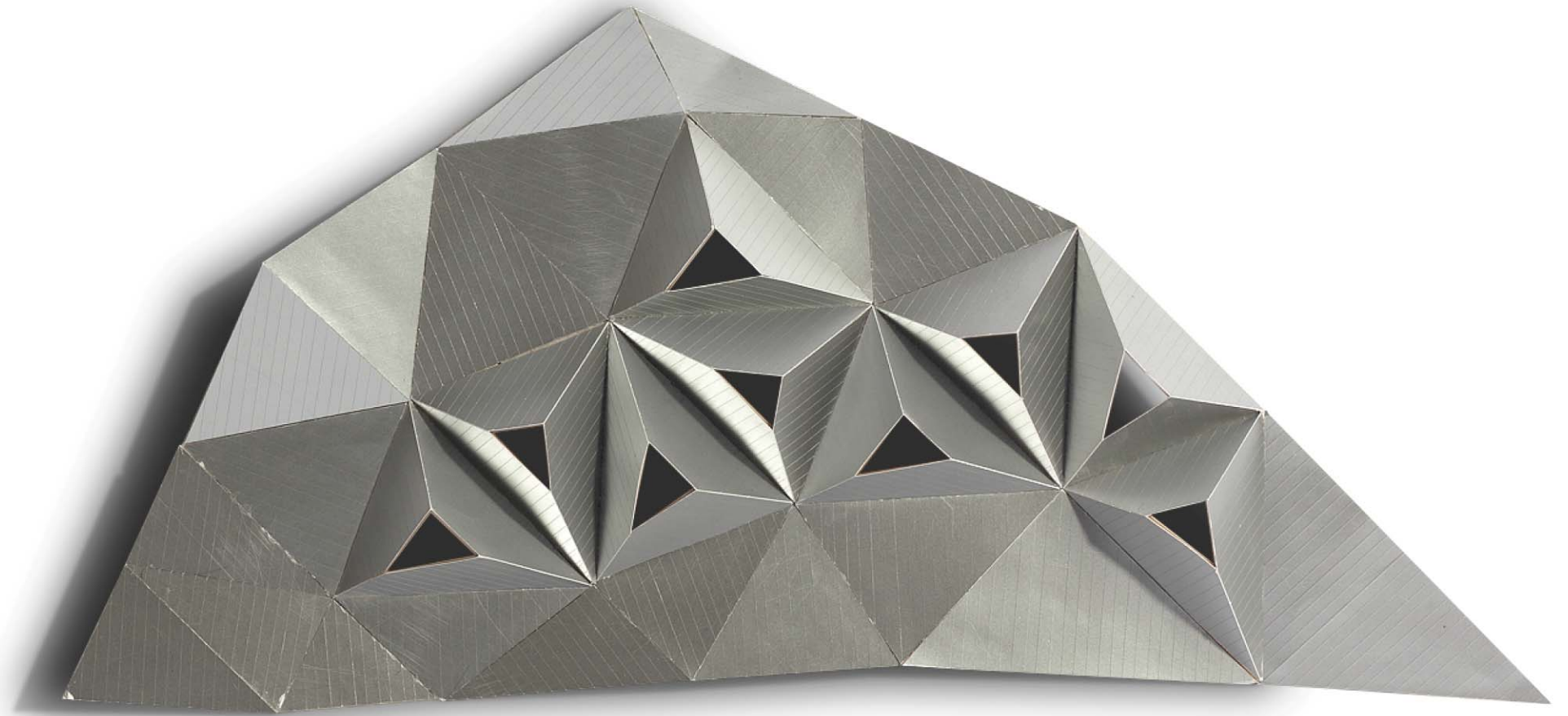



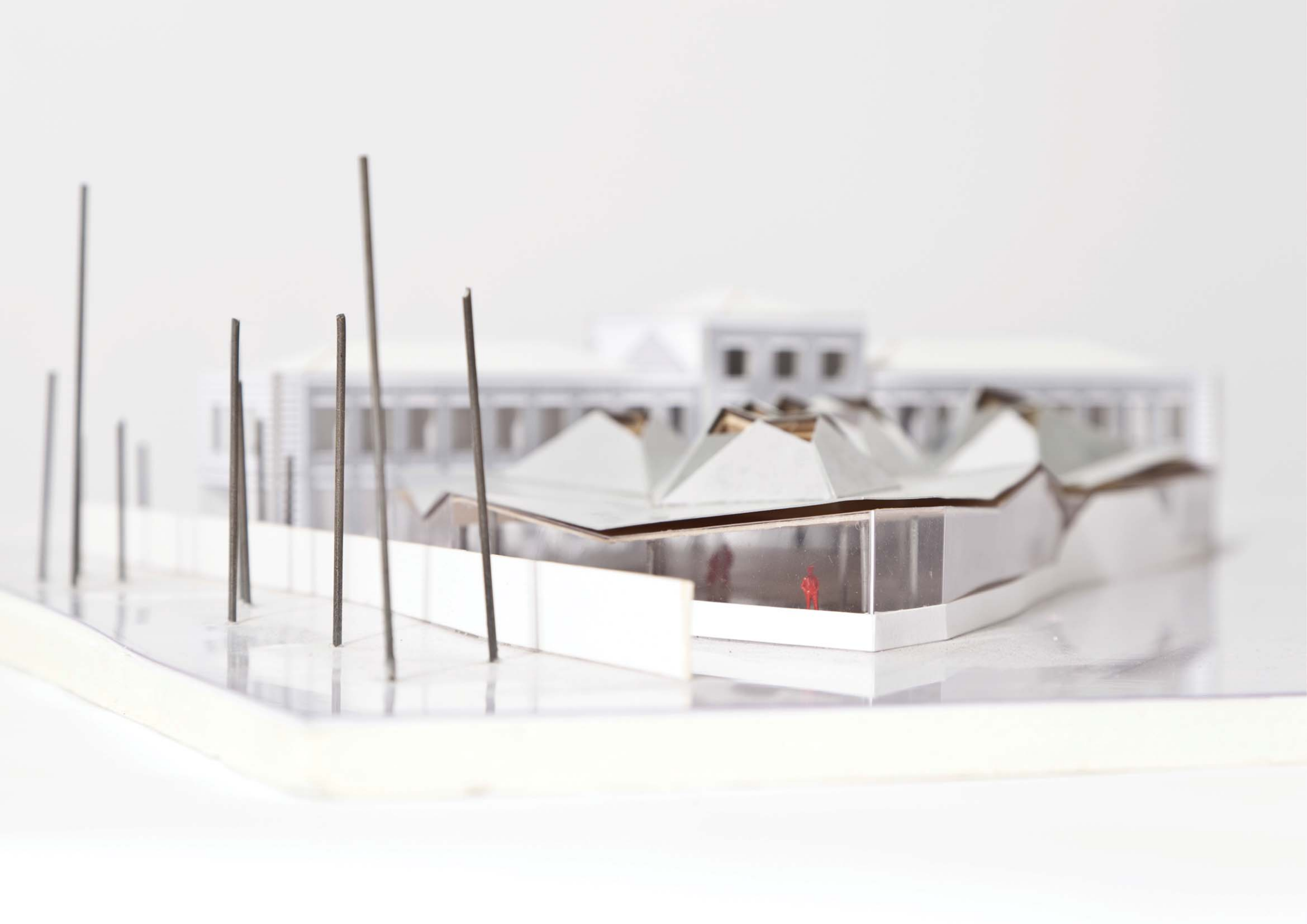















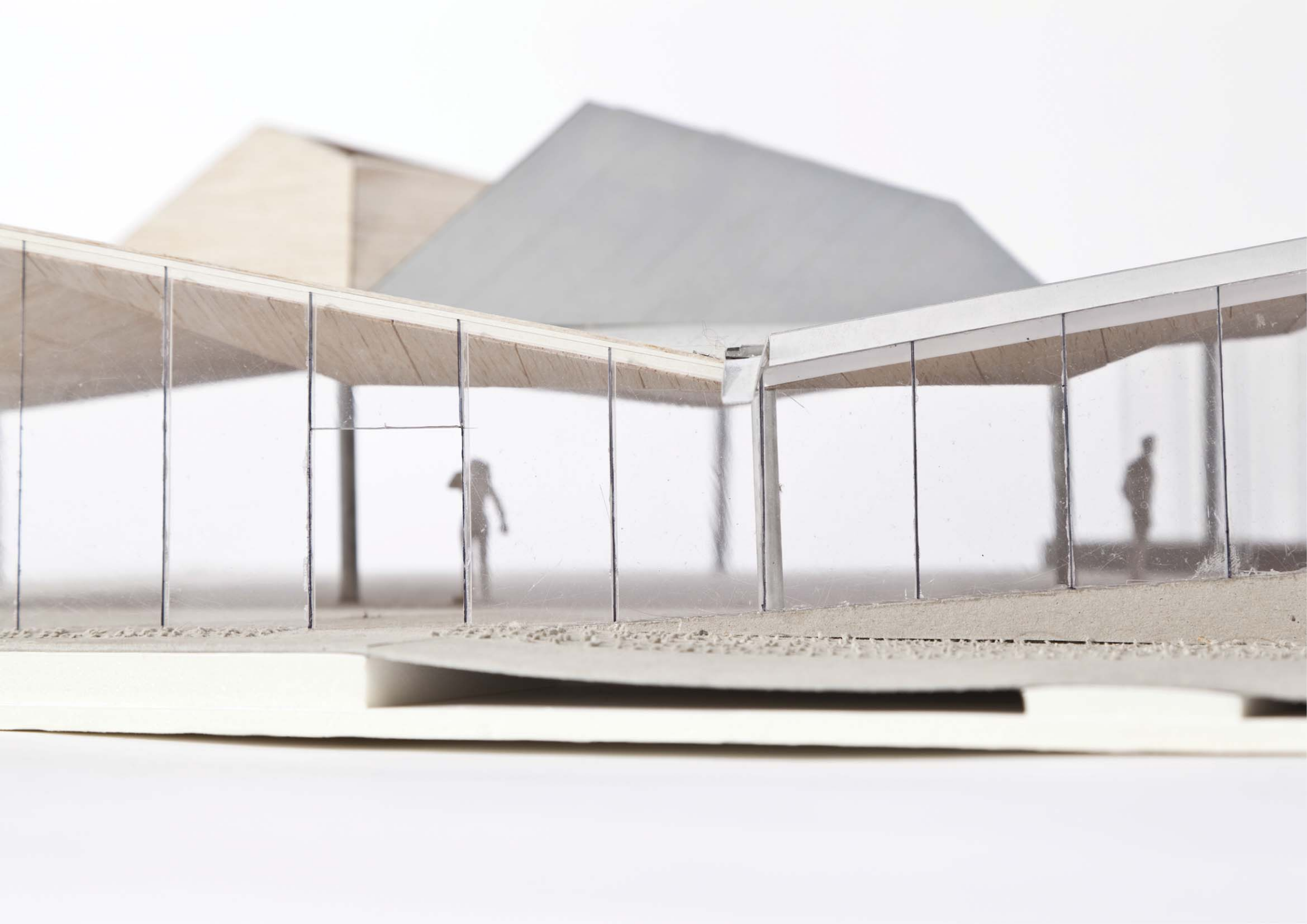

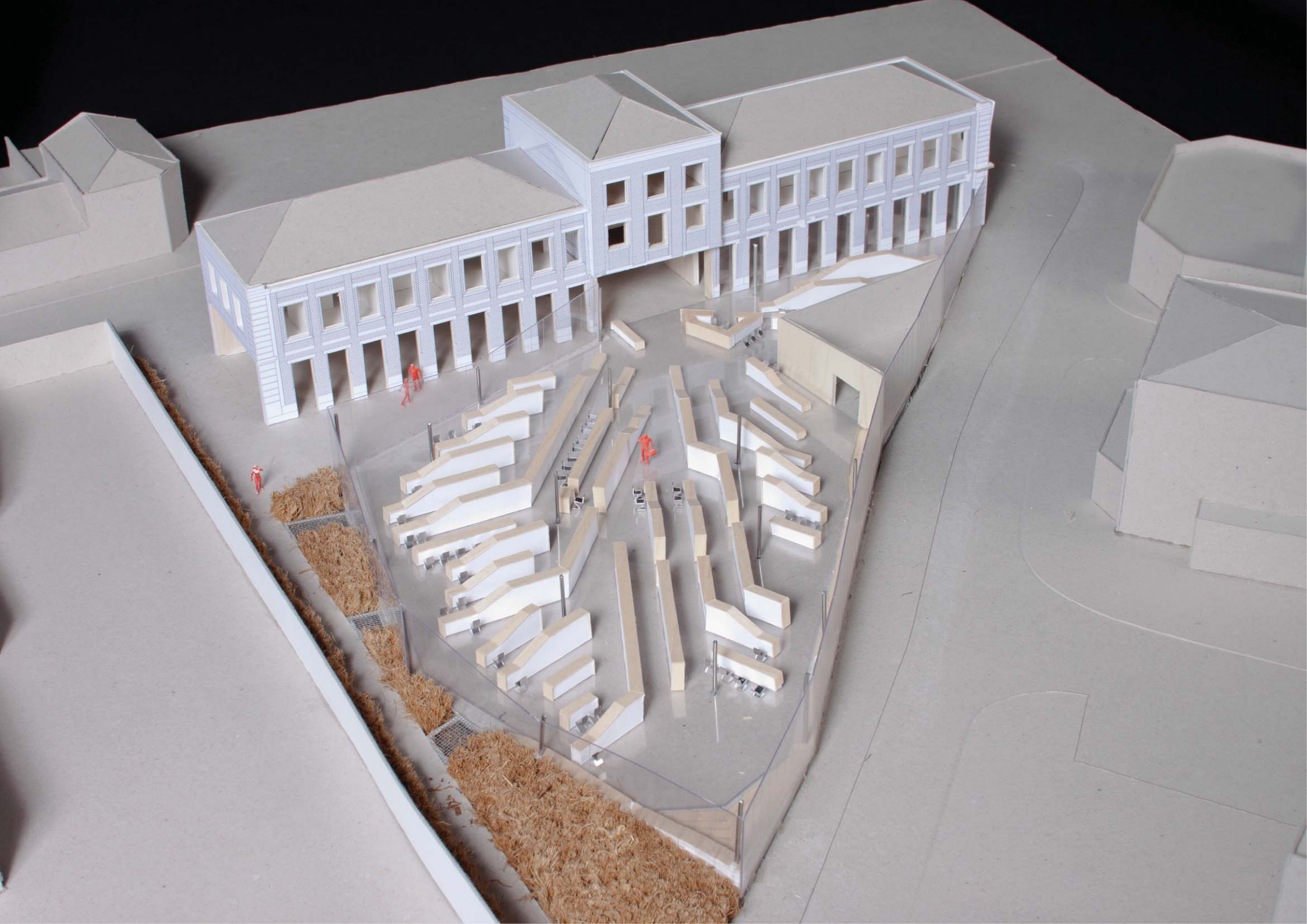









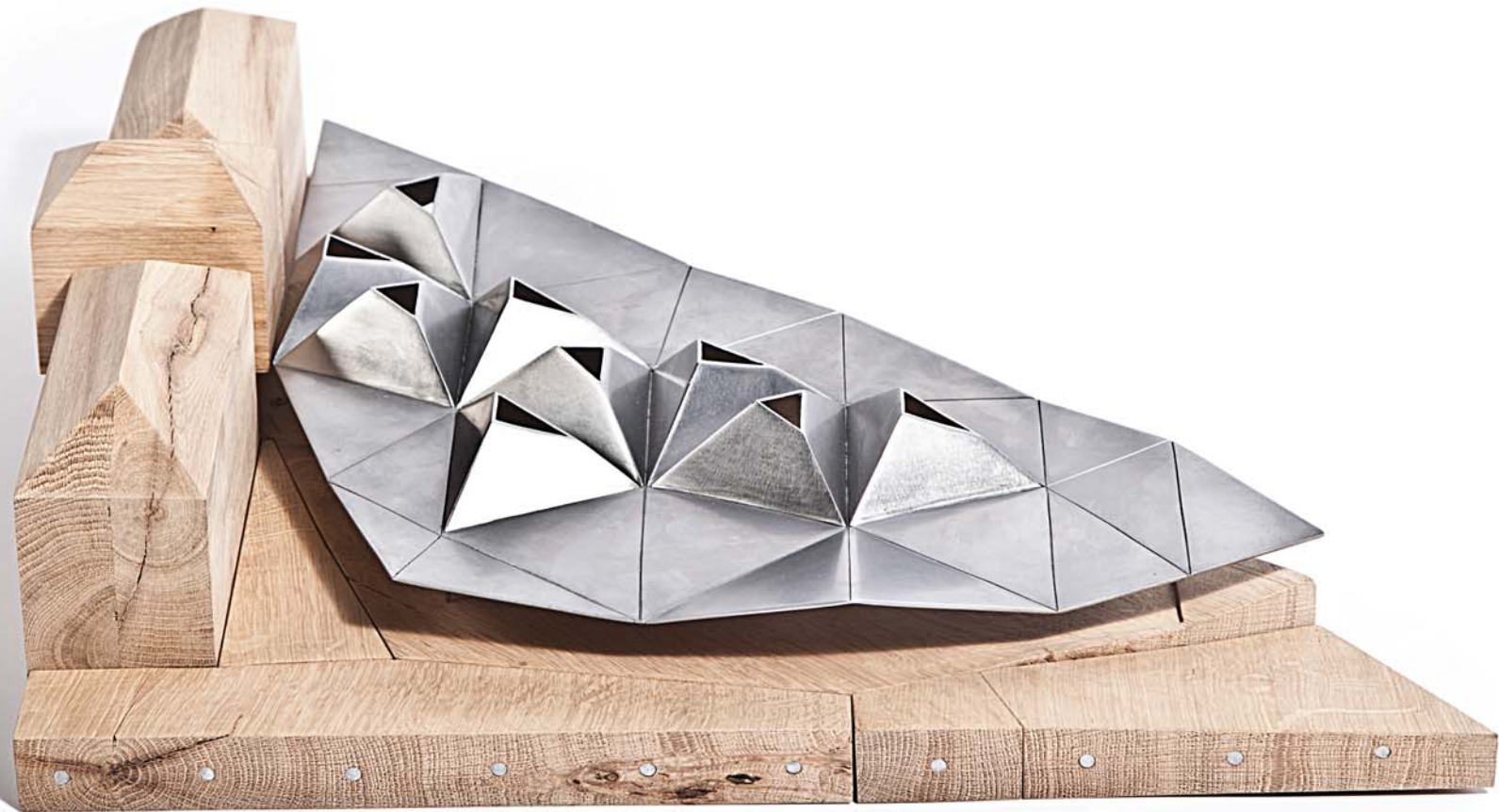

















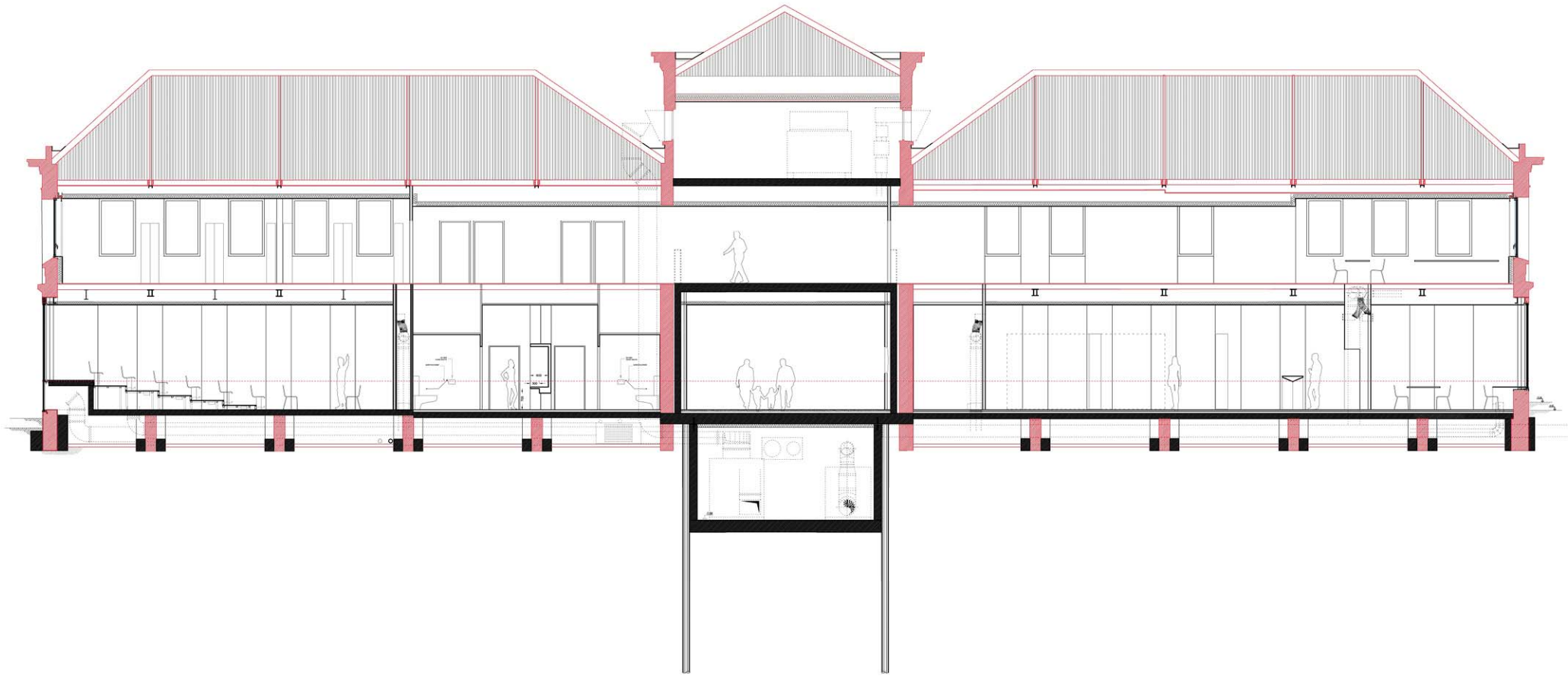



CENTRE ESCAMPS

PIETONS, PRENEZ LE
TROTTOIR D'EN FACE

SORTIE
DE
CAMIONS





14 | 12 |

13 | 11 |











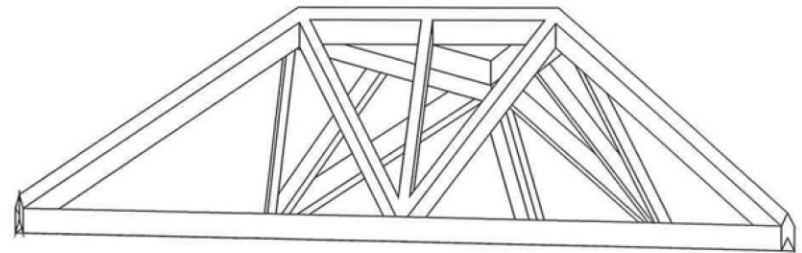
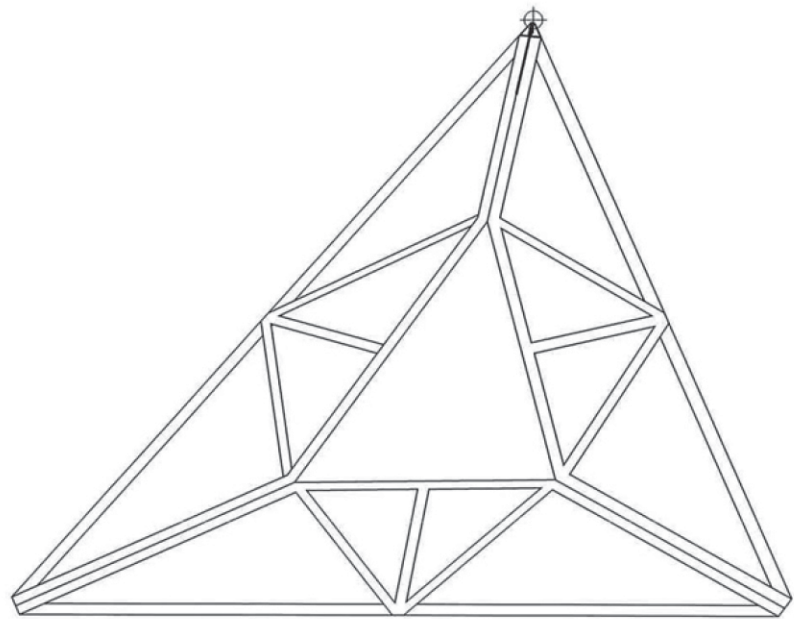
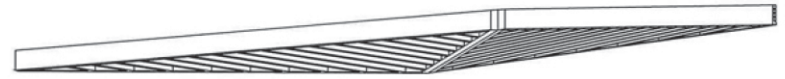
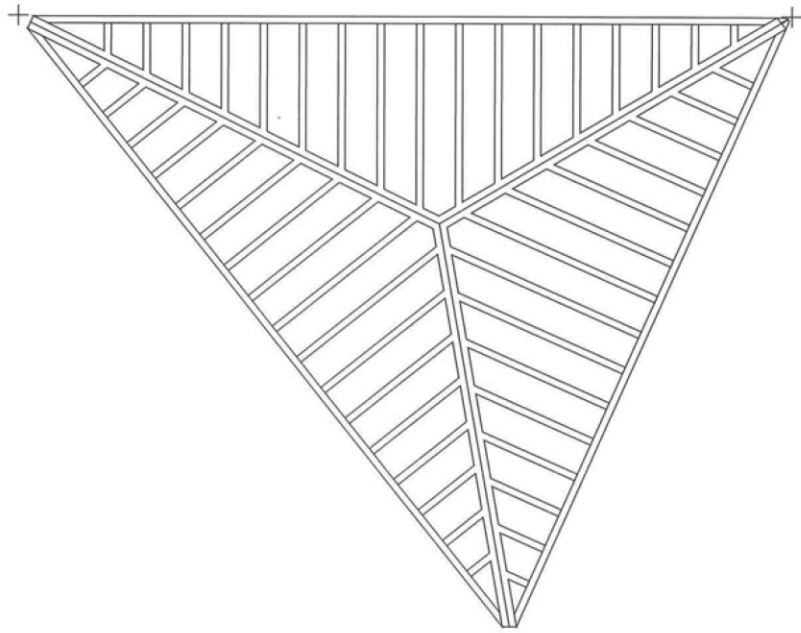



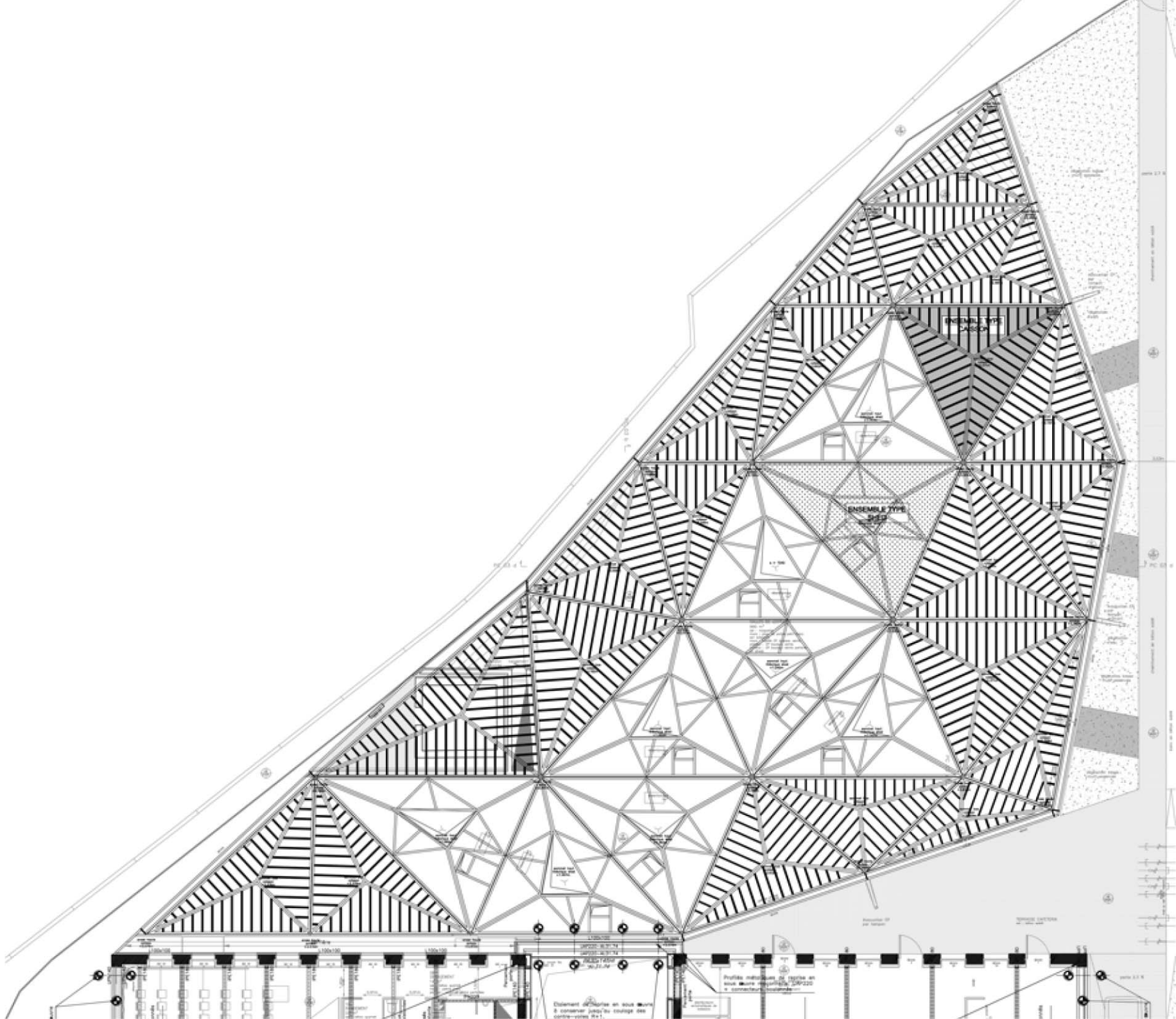

Détail de charnière en acier
à conserver jusqu'au montage des
coulisses-crois 04.1

Profilés en IPE
à conserver jusqu'au montage des
coulisses-crois 04.1

PROFILS EN IPE

PROFILS EN IPE

PROFILS EN IPE

PROFILS EN IPE



PROFILS EN IPE

PROFILS EN IPE

PROFILS EN IPE

PROFILS EN IPE

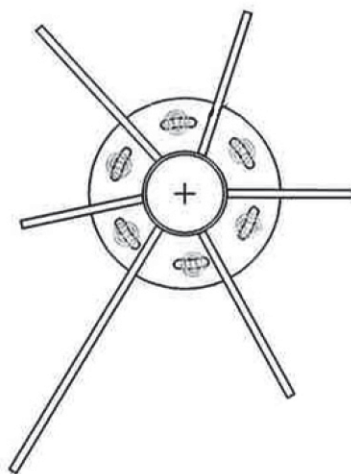
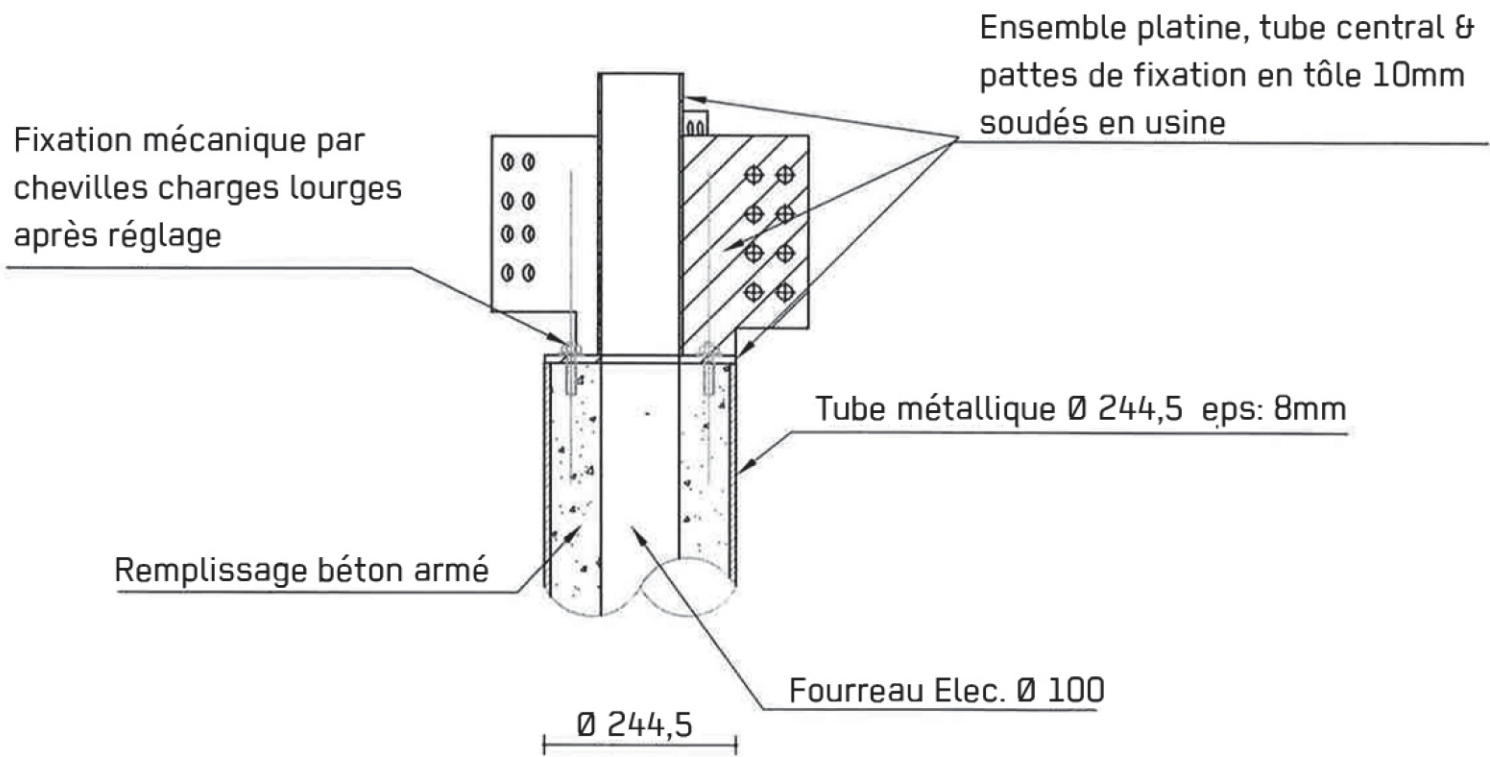















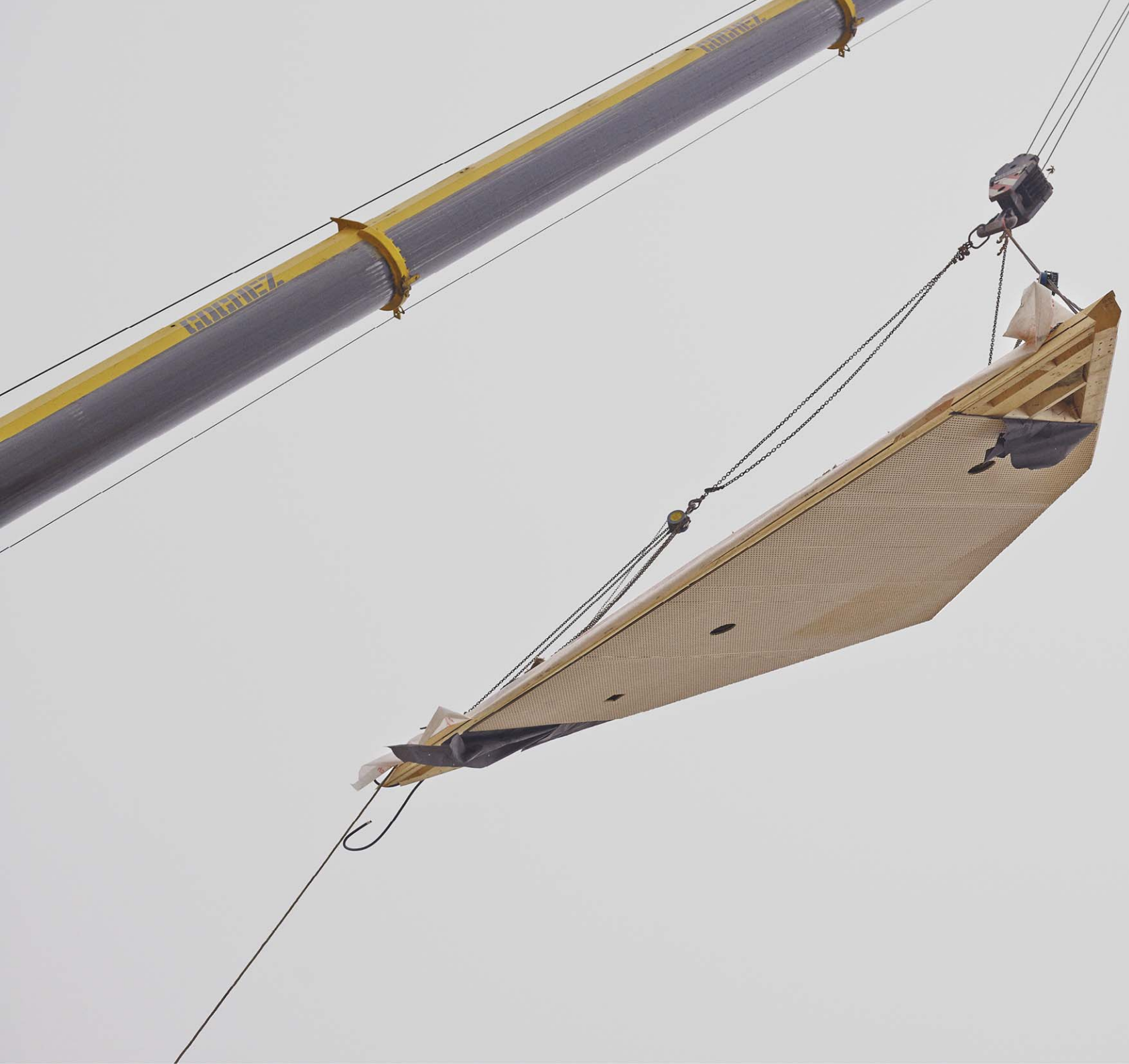









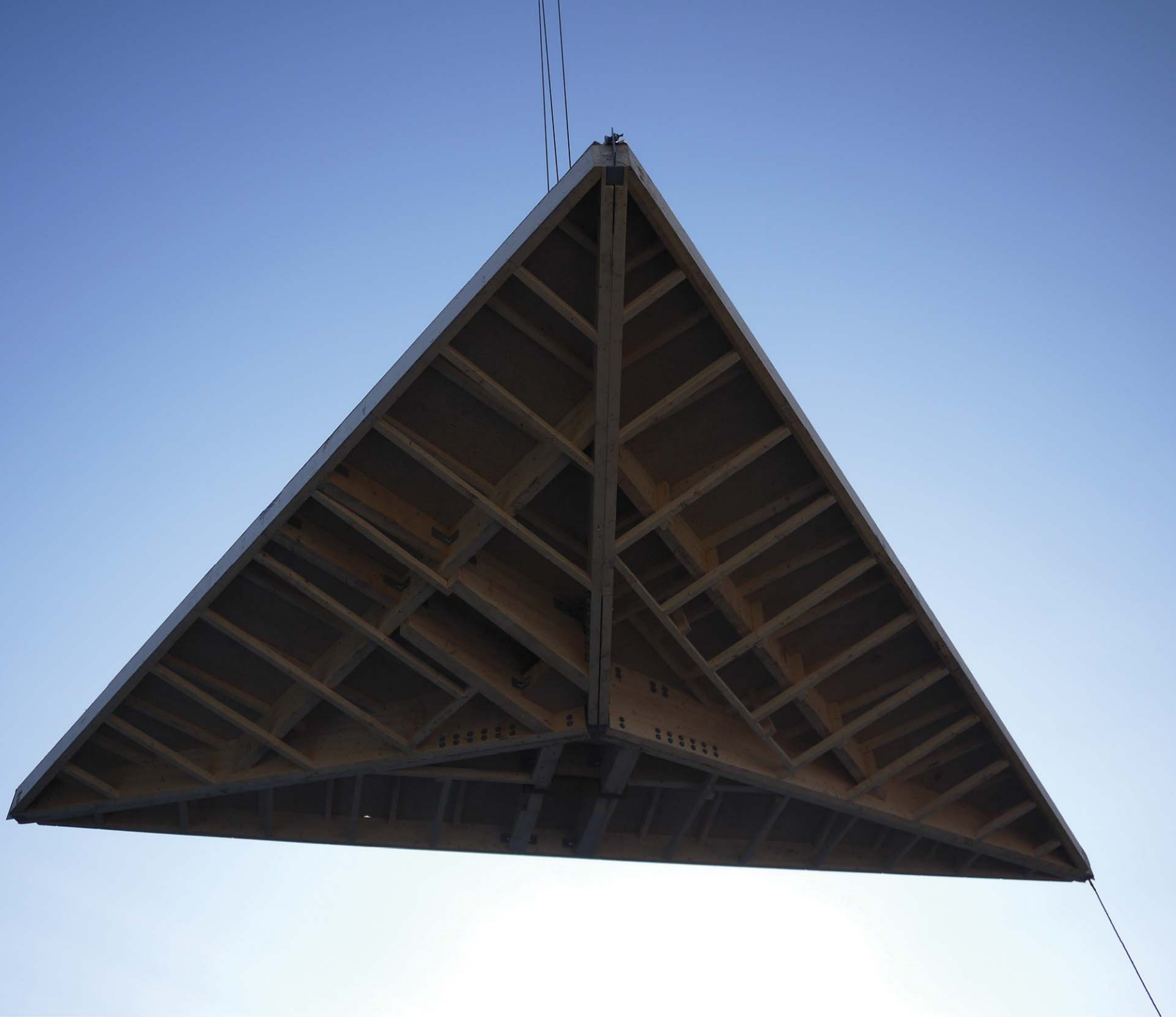



















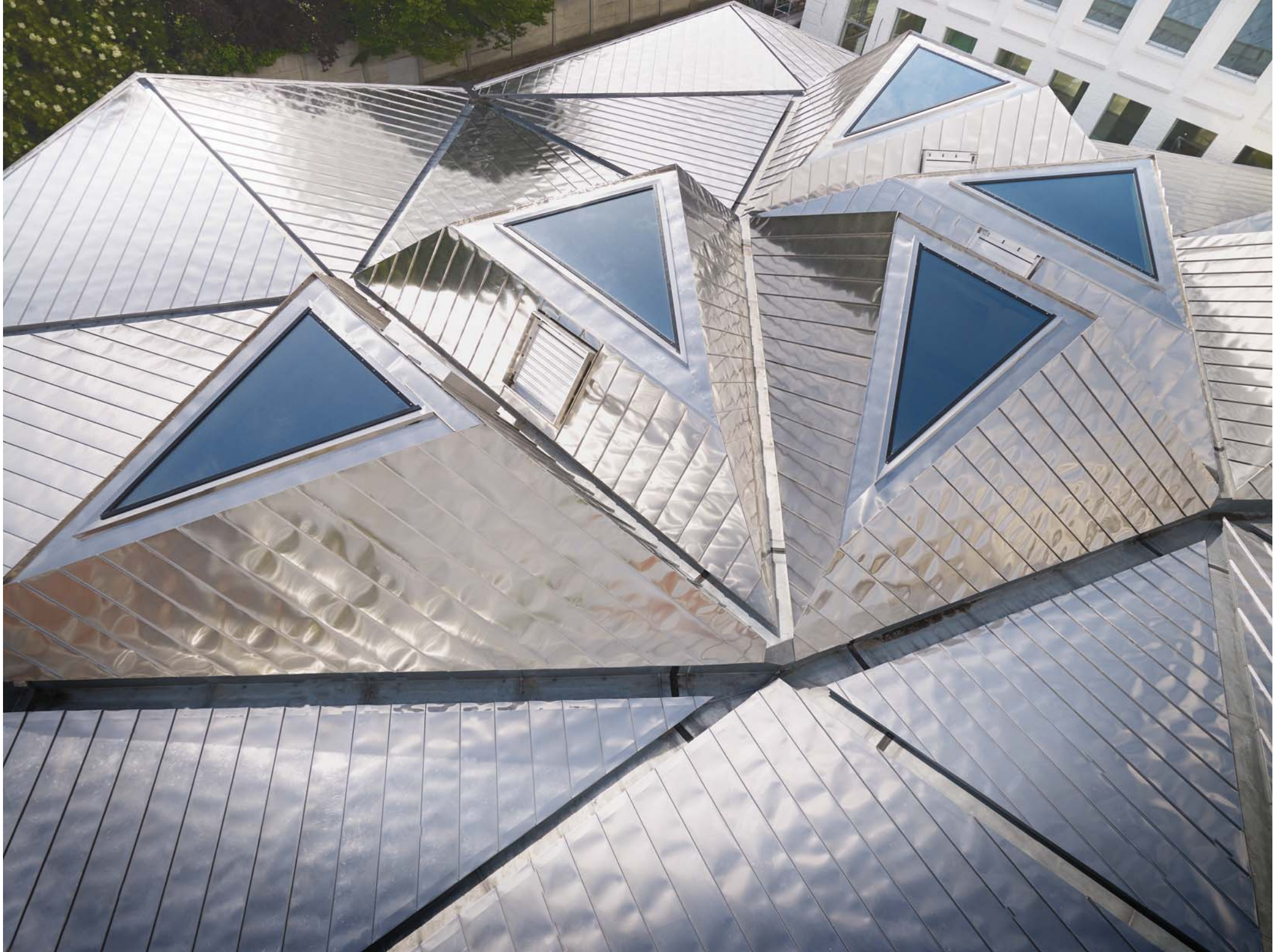





Mangas













